



Ethicon Products











W O R L D W I D E

PDS II









(Polydioxanone)





Monofilament Suture

(Polydioxanone) Monofilament Suture





| Needle length and description | Length | Colour | Gauge | | | | |
|--|--------|---------------|------------------|---------------|--------------------------------|---------------|---------------|
| ⊙ 1/2 circle ETHIGUARD Blunt Point | | | 3-0 2 | 2-0 3 | 0 3.5 | 1 4 | 2 5 |
| MHB-1  | 31mm | 70cm | violet | W9958H | W9959H | | |
| BT-3  | 45mm | 90cm | violet | | | W9965H | |
| CTXB  | 48mm | 150cm loop | violet | | | W9966H | W9967H |
| ⊙ 5/8 circle ETHIGUARD Blunt Point | | | 3-0 2 | 2-0 3 | 0 3.5 | 1 4 | 2 5 |
| UB-110  | 110mm | 240cm loop | violet | | W9968 | | |
| ⊙ 3/8 circle Taper Point | | | 7-0 0.5 | 6-0 0.7 | 5-0 1 | 4-0 1.5 | 3-0 2 |
| BV-1  | 9.3mm | 45cm 70cm | violet violet | Z1701E | W9091H Z1702H | | |
| BV  | 11mm | 45cm 70cm | violet violet | | W9093H Z1002H | | |
| C-1  | 13mm | 45cm | violet | W9095H | W9096H | | |
| C-1  | 13mm | 70cm | violet | | | Z1013H | |
| C-1  | 13mm | 70cm | violet | | Z1721H | | |
| BB  | 17mm | 70cm | violet | | | W9073H | W9077H |
| ⊖ 1/2 circle Taper Point plus | | | 6-0 0.7 | 5-0 1 | 4-0 1.5 | 3-0 2 | 2-0 3 |
| RB-2  | 13mm | 45cm | violet | W9100H | W9101H | W9102H | |

(Polydioxanone) Monofilament Suture



| Needle length and description | Length | Colour | Gauge | | | | | | | |
|--|--------|--------|------------|----------|------------|----------|----------|----------|--------|--------|
| ⊖ 1/2 circle Taper Point plus | | | 6-0 0.7 | 5-0 1 | 4-0 1.5 | 3-0 2 | 2-0 3 | 0 3.5 | 1 4 | |
| RB-2  | 13mm | 70cm | violet | | W9201H | | | | | |
| RB-1 plus  | 17mm | 90cm | violet | | W9108H | W9109H | | | | |
| SH-2 plus  | 20mm | 70cm | violet | | | W9115H | W9116H | | | |
| SH  | 26mm | 70cm | violet | | | | | | W9205H | |
| SH plus  | 26mm | 70cm | violet | | | | W9124H | W9125H | | |
| MH-1 plus  | 31mm | 70cm | violet | | | W9131H | W9132H | W9133H | W9210H | W9211H |
| MH-1 plus  | 31mm | 90cm | violet | | | | W9134H | | | |
| LH  | 40mm | 70cm | violet | | | | W9152H | W9151H | | |

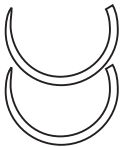
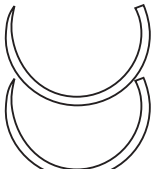
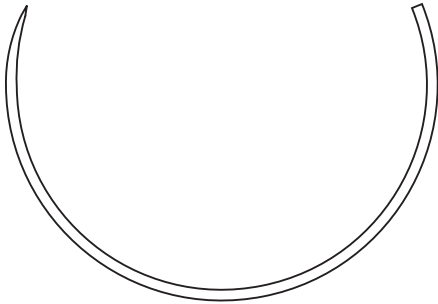
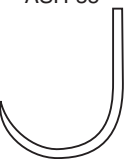





| ⊙ 1/2 circle Taper Point (heavier wire diameters) | | | | 2-0 3 | 0 3.5 | 1 4 | 2 5 | 4 6 | 5 7 | 7 9 |
|--|------|---------------|------------------|----------|----------|--------|--------|--------|--------|--------|
| CT-2  | 26mm | 70cm | violet | Z333E | Z334E | Z335E | | | | |
| CT-1  | 36mm | 70cm | violet | Z339H | Z340H | Z341H | | | | |
| CT  | 40mm | 70cm 90cm | violet violet | | W9233H | W9234H | W9235H | | | |
| MO-2  | 40mm | 150cm loop | violet | | W9236H | W9237H | | | | |
| MO-45  | 45mm | 90cm | violet | | | W9248H | | | | |



(Polydioxanone) Monofilament Suture

| Needle length and description | Length | Colour | Gauge | | | | |
|--|--------|--------|------------|------------|----------|------------|----------|
| ⊙ 1/2 circle Taper Point (heavier wire diameters) | | | 2-0 3 | 0 3.5 | 1 4 | 2 5 | 4 6 |
|  <p>CTX</p> <p>48mm</p> <p>90cm</p> <p>violet</p> <p>W9255H W9254H W9256H</p> | | | | | | | |
|  <p>CTX heavy</p> <p>48mm</p> <p>150cm loop</p> <p>violet</p> <p>W9261H W9262H</p> | | | | | | | |
| ⊙ 5/8 circle Taper Point | | | 3-0 2 | 2-0 3 | 0 3.5 | 1 4 | 2 5 |
|  <p>UR-6</p> <p>26mm</p> <p>70cm</p> <p>violet</p> <p>Z605E</p> | | | | | | | |
|  <p>UR-5</p> <p>36mm</p> <p>70cm</p> <p>violet</p> <p>VAA2973E</p> | | | | | | | |
|  <p>MF-110 HVY</p> <p>110mm</p> <p>150cm loop</p> <p>violet</p> <p>W9168</p> | | | | | | | |
| ⊙ J Needle Taper Point | | | 3-0 2 | 2-0 3 | 0 3.5 | 1 4 | 2 5 |
|  <p>ASH-35</p> <p>36mm</p> <p>70cm</p> <p>violet</p> <p>W9219H</p> | | | | | | | |
| ⊙ 3/8 circle CC Needle | | | 7-0 0.5 | 6-0 0.7 | 5-0 1 | 4-0 1.5 | 3-0 2 |
|  <p>CC</p> <p>9.3mm</p> <p>70cm</p> <p>violet</p> <p>Z1751E</p> | | | | | | | |

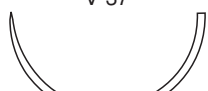
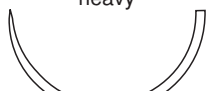
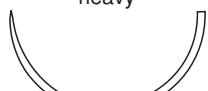

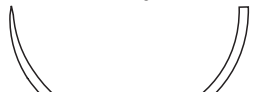
(Polydioxanone) Monofilament Suture

| Needle length and description | Length | Colour | Gauge | | | | | | |
|---|--------|--------|---------------|---------------|----------|------------|----------|----------|----------|
|  3/8 circle CC Needle | | | 7-0 0.5 | 6-0 0.7 | 5-0 1 | 4-0 1.5 | 3-0 2 | 2-0 3 | 0 3.5 |
|  CC 9.3mm | 70cm | violet | Z1711E | Z1712H | | | | | |
|  CC-1 13mm | 70cm | violet | | Z1032H | | | | | |

|  1/2 circle TAPERCUT | | | | 3-0 2 | 2-0 3 | 0 3.5 | 1 4 | 2 5 | 4 6 | 5 7 |
|--|---------------|------------------|---------------|---------------|----------|---------------|---------------|--------|--------|--------|
|  V-7 26mm | 70cm | violet | W9179H | W9184H | | | | | | |
|  V-34 36mm | 70cm 90cm | violet violet | | W9380H | | W9381H | W9352H | | | |
|  V-34 heavy 36mm | 90cm | violet | | | | W9355H | W9382H | | | |
|  V-37 40mm | 90cm | violet | | | | W9366H | W9370H | | | |
|  V-37 heavy 40mm | 90cm | violet | | | | W9371H | W9374H | | | |
|  V-37 heavy 40mm | 240cm loop | violet | | | | | W9394 | | | |
|  V-39 45mm | 90cm | violet | | | | | W9385H | | | |
|  V-40 48mm | 90cm | violet | | | | W9395H | W9396H | | | |

|  J Needle TAPERCUT | | | | 3-0 2 | 2-0 3 | 0 3.5 | 1 4 | 2 5 | 4 6 | 5 7 |
|--|------|--------|--|----------|----------|---------------|---------------|--------|--------|--------|
|  V-38 31mm | 70cm | violet | | | | W9333H | W9334H | | | |





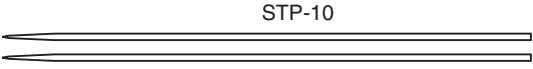

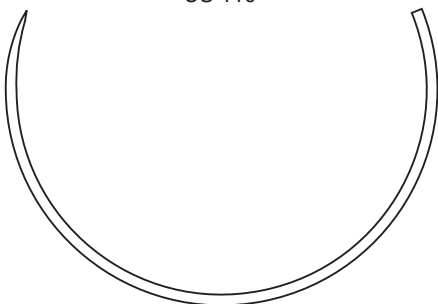
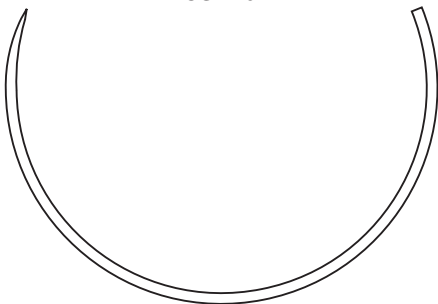



(Polydioxanone) Monofilament Suture

| Needle length and description | Length | Colour | Gauge | | | | |
|---|--------|--------|----------|----------|----------|---------------|--------|
| ▼ 1/2 circle Reverse Cutting | | | 3-0 2 | 2-0 3 | 0 3.5 | 1 4 | 2 5 |
|  <p>OS-4</p> <p>22mm</p> | 70cm | violet | | | | W9286H | |
|  <p>CP</p> <p>40mm</p> | 90cm | violet | | | | W9324H | |
|  <p>CPX</p> <p>48mm</p> | 90cm | violet | | | | W9299H | |

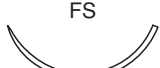
| | | | | | | | |
|--|------|--------|----------|--------------|----------|--------|--------|
| ▲ Straight TROCAR POINT | | | 3-0 2 | 2-0 3 | 0 3.5 | 1 4 | 2 5 |
|  <p>STP-10</p> <p>254mm</p> <p>image not to scale</p> | 70cm | violet | | Z997C | | | |

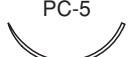
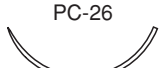

| | | | | | | | |
|--|-------|--------|----------|----------|----------|--------------|--------|
| ▼ 5/8 circle SPATULATED | | | 3-0 2 | 2-0 3 | 0 3.5 | 1 4 | 2 5 |
|  <p>US-110</p> <p>110mm</p> | 150cm | violet | | | | W9279 | |
|  <p>US-110</p> <p>110mm</p> <p>240cm loop</p> | | violet | | | | W9269 | |

(Polydioxanone) Monofilament Suture

| Needle length and description | | Length | Colour | Gauge | | | | | | |
|---|------|--------|--------|------------|------------|------------|----------|----------|----------|--------|
| ▼ 3/8 circle Reverse Cutting - PRIME Needle | | | | 5-0 1 | 4-0 1.5 | 3-0 2 | 2-0 3 | 0 3.5 | 1 4 | 2 5 |
|  PS-3 | 16mm | 45cm | undyed | W9872H | W9873H | | | | | |
|  PS-2 | 19mm | 45cm | undyed | | W9874H | | | | | |
| ▼ 3/8 circle Reverse Cutting - P Needle | | | | 6-0 0.7 | 5-0 1 | 4-0 1.5 | 3-0 2 | 2-0 3 | 0 3.5 | 1 4 |
|  P-1 | 11mm | 45cm | violet | Z487E | | | | | | |
|  PS | 26mm | 70cm | undyed | | | W9624H | | W9626H | | |
| ▲ 3/8 circle Reverse Cutting | | | | 6-0 0.7 | 5-0 1 | 4-0 1.5 | 3-0 2 | 2-0 3 | 0 3.5 | 1 4 |
|  FS-2 | 19mm | 45cm | undyed | | | W9950H | | | | |
| ▼ 3/8 circle Reverse Cutting | | | | 6-0 0.7 | 5-0 1 | 4-0 1.5 | 3-0 2 | 2-0 3 | 0 3.5 | 1 4 |
|  FS | 26mm | 45cm | undyed | | | | W9957H | | | |
| ▲ 3/8 circle Conventional Cutting - PRIME Needle | | | | 6-0 0.7 | 5-0 1 | 4-0 1.5 | 3-0 2 | 2-0 3 | 0 3.5 | 1 4 |
|  PC-1 | 13mm | 45cm | undyed | W9861H | W9863H | | | | | |
|  PC-3 | 16mm | 45cm | undyed | | W9865H | W9867H | | | | |
|  PC-5 | 19mm | 45cm | undyed | | W9869H | W9868H | | | | |
|  PC-25 | 26mm | 45cm | undyed | | | W9870H | | | | |
| ▲ 3/8 circle Conventional Cutting - P Needle | | | | 6-0 0.7 | 5-0 1 | 4-0 1.5 | 3-0 2 | 2-0 3 | 0 3.5 | 1 4 |
|  PC-5 | 19mm | 45cm | undyed | | | W9615H | | | | |
|  PC-26 | 26mm | 70cm | undyed | | | | W9625H | | | |
|  PCLX | 36mm | 70cm | undyed | | | | | W9631H | | |
| ▲ 3/8 circle Conventional Cutting | | | | 6-0 0.7 | 5-0 1 | 4-0 1.5 | 3-0 2 | 2-0 3 | 0 3.5 | 1 4 |
|  CFS-3 | 16mm | 70cm | undyed | | W9733H | W9734H | | | | |

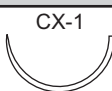
(Polydioxanone) Monofilament Suture

| Needle length and description | Length | Colour | Gauge | | | | |
|---|--------|--------|------------|----------|------------|----------|---------------|
| ▲ 1/2 circle Conventional Cutting | | | 6-0 0.7 | 5-0 1 | 4-0 1.5 | 3-0 2 | 2-0 3 |
|  CX-1 | 22mm | 45cm | undyed | | | | W9740H |

| Needle length and description | Length | Colour | Gauge | | | | |
|---|--------|--------|------------|----------|---------------|---------------|---------------|
| ▼ Straight Cutting | | | 6-0 0.7 | 5-0 1 | 4-0 1.5 | 3-0 2 | 2-0 3 |
|  KS | 60mm | 70cm | undyed | | | W9720H | W9715H |
|  KS fine | 60mm | 70cm | undyed | | W9716H | W9714H | |
|  KS fine 2 beads & 2 collars | 60mm | 90cm | undyed | | | W9721 | |

| Needle length and description | Length | Colour | Gauge | | | | | | |
|--|--------|--------|------------|----------|----------------|----------|----------|----------|--------|
| ◎ Straight Point | | | 6-0 0.7 | 5-0 1 | 4-0 1.5 | 3-0 2 | 2-0 3 | 0 3.5 | 1 4 |
|  ST-4 <u>VISI-BLACK</u> | 19mm | 20cm | violet | | MIC102H | | | | |

(Polydioxanone) Monofilament Suture

Ligatures and Non-needled Sutures

ENDOLOOP Ligature

Pre-tied ligatures with Cannula for use during endoscopic surgery

| Gauge | | violet 45cm |
|-------|-----|----------------|
| 2-0 | 3 | MIC109G |
| 0 | 3.5 | MIC110G |
| 1 | 4 | MIC111G |



Capitalised product names are trademarks of ETHICON.