



Ethicon Products



W O R L D W I D E















PROLENE

Monofilament













Polypropylene Suture

Monofilament Polypropylene Suture



Needle length and description	Length	Colour	Gauge							
⊙ 1/2 circle ETHIGUARD Blunt Point			2-0 3	0 3.5	1 4	2 5	4 6	5 7	7 9	
 CTB  BT-3	40mm	100cm	blue			W8998				
	45mm	100cm	blue			W8999				





⊙ 3/8 circle Taper Point				8-0 0.4	7-0 0.5	6-0 0.7	5-0 1	4-0 1.5	3-0 2	2-0 3
	BV130-5	6.5mm	13cm	blue	W2775					
	BV130-5 MultiPass Needles	6.5mm	45cm	blue	W2777					
	BV130-5	6.5mm	60cm	blue	F1890					
	BV175-6 VISI-BLACK	8mm	60cm	blue	8841H	8335H				
	BV175-6	8mm	60cm	blue	8741H	8735H				
	BV175-7 VISI-BLACK	8mm	60cm	blue	8967H	8966H				
	BV175-7	8mm	60cm	blue	8767H	8766H				
	BV175-8 VISI-BLACK	9.3mm	60cm	blue		W8304				
	BV175-8	9.3mm	60cm	blue		W8702				
	BV175-8 STRAIGHT PACK	9.3mm	4x60cm	blue		W8702S				
	BV-1 VISI-BLACK	9.3mm	60cm	blue		W8305				
	BV-1	9.3mm	45cm 60cm	blue blue		W8711 W8712				
	BV-1 STRAIGHT PACK	9.3mm	4x60cm	blue		W8712S				
	BV	11mm	60cm	blue		W8597				
	C-1 VISI-BLACK	13mm	60cm 75cm	blue blue		W8307 W8316	W8321			

Monofilament Polypropylene Suture





Needle length and description		Length	Colour	Gauge						
⊙ 3/8 circle Taper Point				8-0 0.4	7-0 0.5	6-0 0.7	5-0 1	4-0 1.5	3-0 2	2-0 3
 C-1	13mm	60cm 75cm	blue blue		W8725	W8718 W8706				
 C-1	13mm	75cm	blue				W8890			
⊙ 1/2 circle Taper Point				8-0 0.4	7-0 0.5	6-0 0.7	5-0 1	4-0 1.5	3-0 2	2-0 3
 RB-2 VISI-BLACK	13mm	75cm	blue				W8310			
 RB-2	13mm	75cm	blue				W8710			
 RB-1 VISI-BLACK	17mm	90cm	blue				W8330	W8329		
 RB-1	17mm	90cm	blue				W8556	W8557	W8558	
 SH-2 VISI-BLACK	20mm	90cm	blue					W8340		
 SH-2	20mm	90cm	blue					W8761		
 SH-1	22mm	75cm	blue						W8770	
 SH VISI-BLACK	26mm	90cm	blue					W8355	W8354	
 SH	26mm	75cm 90cm 120cm	blue blue blue				F1821	W8521	W8522 W8534	
 JMH-1 VISI-BLACK	31mm	120cm	blue						X1295H	

Monofilament Polypropylene Suture

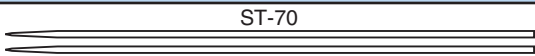











Needle length and description	Length	Colour	Gauge					
⊙ 1/2 circle Taper Point			8-0 0.4	7-0 0.5	6-0 0.7	5-0 1	3-0 2	2-0 3
MH-1 	31mm	75cm	blue					W295
MH-1 	31mm	90cm	blue				W8525	W8526

⊙ 1/2 circle Taper Point (heavier wire diameters)				2-0 3	0 3.5	1 4	2 5	5 7	7 9
MO-5 	31mm	100cm	blue		W8430				
CT 	40mm	100cm	blue			W742			
MO-2 	40mm	100cm	blue		W8434				
TP-1 	65mm	100cm	blue			W8401			









⊙ Straight Taper Point				2-0 3	0 3.5	1 4	2 5	5 7	7 9
ST-70 	70mm	75cm	blue	W8400					

⊙ 3/8 circle CC Needle				8-0 0.4	7-0 0.5	6-0 0.7	5-0 1	3-0 2	2-0 3
CC VISI-BLACK 	8mm	60cm	blue	W8101					
CC MultiPass Needles 	9.3mm	60cm 75cm	blue blue	W8703	W8704	W8807 F1832			
CC HEMO-SEAL 	9.3mm	60cm	blue				W8662		
CC-11 	11mm	60cm	blue		W8801	W8802			

Monofilament Polypropylene Suture

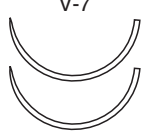

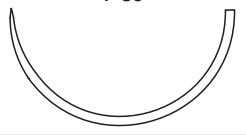
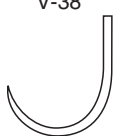

Needle length and description		Length	Colour	Gauge						
⊕ 3/8 circle CC Needle				8-0 0.4	7-0 0.5	6-0 0.7	5-0 1	4-0 1.5	3-0 2	2-0 3
 CC-1 MultiPass Needles	13mm	60cm 75cm	blue blue		W8813	W8707 W8814				
 CC-1	13mm	75cm	blue				W8721			
⊕ 1/2 circle CC Needle				8-0 0.4	7-0 0.5	6-0 0.7	5-0 1	4-0 1.5	3-0 2	2-0 3
 CC-5	11mm	60cm	blue				W8803			
 CC-4	13mm	60cm 75cm	blue blue			W8815	W8816			
 CC-4 HEMO-SEAL	13mm	60cm 75cm	blue blue				W8664	W8665		
 CC-16	16mm	90cm	blue				W8830	W8831		
 CC-16 HEMO-SEAL	16mm	90cm	blue						W8667	
 CC-20	20mm	90cm	blue					W8840		
 CC-25	26mm	90cm 120cm	blue blue					W8845	W8844 W8895	W8843 W8896
 CC-30	31mm	90cm	blue						W8849	W8850
 CC-40	40mm	90cm	blue						W8851	W8852
⊕ MULTI-CURVE CC Needle				8-0 0.4	7-0 0.5	6-0 0.7	5-0 1	4-0 1.5	3-0 2	2-0 3
 ACC VISI-BLACK	9.3mm	75cm	blue		EH8021E	EH8025H				





Monofilament Polypropylene Suture



Needle length and description		Length	Colour	Gauge						
⊕ MULTI-CURVE CC Needle				8-0 0.4	7-0 0.5	6-0 0.7	5-0 1	4-0 1.5	3-0 2	2-0 3
ACC-1 VISI-BLACK 	13mm	75cm	blue			EH8030H	EH8036H			
▼ 3/8 circle TAPERCUT				8-0 0.4	7-0 0.5	6-0 0.7	5-0 1	4-0 1.5	3-0 2	2-0 3
V-4 	17mm	75cm	blue				F2829			
V-26 	26mm	75cm 120cm	blue blue					F2845 F2850		
▼ 1/2 circle TAPERCUT				4-0 1.5	3-0 2	2-0 3	0 3.5	1 4	2 5	4 6
V-5 	17mm	90cm	blue	W8935	W8936	W8937				
V-7 	26mm	90cm	blue		W8976	W8977				
V-34 	36mm	100cm	blue				W486			
V-39 	45mm	100cm	blue					W8450		
▼ J Needle TAPERCUT				4-0 1.5	3-0 2	2-0 3	0 3.5	1 4	2 5	4 6
V-38 	31mm	100cm	blue				W982			
▼ 1/2 circle Reverse Cutting				4-0 1.5	3-0 2	2-0 3	0 3.5	1 4	2 5	4 6
CP 	40mm	100cm	blue				W8470			
CPX 	48mm	100cm	blue					W8475		



Monofilament Polypropylene Suture

Needle length and description	Length	Colour	Gauge						
▲ 1/2 circle TROCAR POINT			4-0 1.5	3-0 2	2-0 3	0 3.5	1 4	2 5	4 6
 TR-30	31mm	100cm	blue					W8440	



Needle length and description	Length	Colour	Gauge						
▼ 3/8 circle Reverse Cutting - PRIME Needle			6-0 0.7	5-0 1	4-0 1.5	3-0 2	2-0 3	0 3.5	1 4
 P-6	8mm	45cm	blue	W8870T					
 P-1	11mm	45cm	blue	W8868T					
 P-3	13mm	45cm	blue	W8871T	W8872T				
 PS-3	16mm	45cm	blue		W8882T	W8884T			
 PS-2	19mm	45cm	blue			W8885T			





Needle length and description	Length	Colour	Gauge						
▼ 3/8 circle Reverse Cutting - P Needle			6-0 0.7	5-0 1	4-0 1.5	3-0 2	2-0 3	0 3.5	1 4
 P-3	13mm	45cm 75cm	clear clear	F2858	8604G F2860				
 PS-3	16mm	75cm	clear	F2859					
 PS-2	19mm	45cm 75cm	blue clear	W8014T	W8015T F2861	F2862			
 PS 2 locking buttons	26mm	45cm	blue			W8625			
 PS	26mm	45cm	blue			W8025T	W8026T		

Needle length and description	Length	Colour	Gauge						
▼ 3/8 circle Reverse Cutting			6-0 0.7	5-0 1	4-0 1.5	3-0 2	2-0 3	0 3.5	1 4
 FS-2	19mm	45cm	blue		W8683				
 FS	26mm	45cm	blue			W8684			

Needle length and description	Length	Colour	Gauge						
▲ 3/8 circle Conventional Cutting - PRIME Needle			6-0 0.7	5-0 1	4-0 1.5	3-0 2	2-0 3	0 3.5	1 4
 PC-3	16mm	45cm	blue	W8873T	W8874T	W8875T			
 PC-5	19mm	45cm	blue		W8876T	W8877T	W8878T		
 PC-25	26mm	45cm	blue	W8886T	W8881T	W8879T	W8880T		

Monofilament Polypropylene Suture

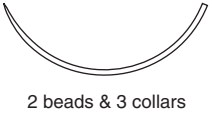
Needle length and description		Length	Colour	Gauge					
▲ 3/8 circle Conventional Cutting - P Needle				6-0 0.7	5-0 1	4-0 1.5	3-0 2	2-0 3	1 4
 PC-3	16mm	45cm	blue	W8005T	W8006T	W8007T			
 PC-5	19mm	45cm	blue		W8010T	W8011T			
 PC-26	26mm	45cm	blue			W8020T	W8021T		

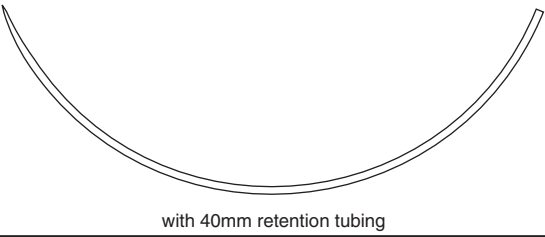
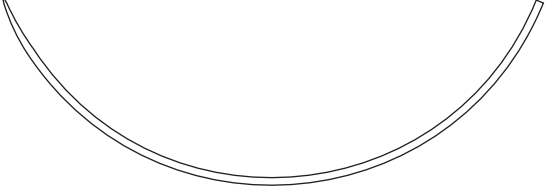

▲ 3/8 circle Conventional Cutting				6-0 0.7	5-0 1	4-0 1.5	3-0 2	2-0 3	1 4
 CFS-3	16mm	75cm	blue				W8549		
 SB-25	26mm	45cm	clear			W534			
 SB-35 2 beads & 3 collars	36mm	75cm	blue				W626		
 SB-35 2 locking buttons	36mm	75cm	blue				W8626		
 FSLX conv	40mm	100cm	blue					W8689	

▲ 3/8 circle Conventional Cutting (Hand Held)				6-0 0.7	5-0 1	4-0 1.5	3-0 2	2-0 3	1 4
 CKP-3 with 40mm retention tubing	90mm	2x50cm	blue						W2989
 CKP-3	90mm	90cm	blue						W987

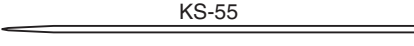
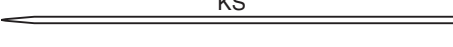
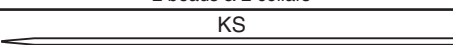
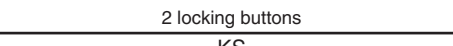
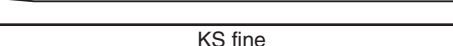
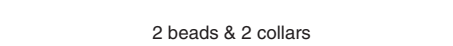
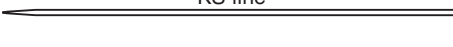
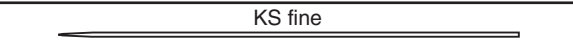

▲ 1/2 circle Conventional Cutting				6-0 0.7	5-0 1	4-0 1.5	3-0 2	2-0 3	1 4
 CX-1	22mm	45cm	blue				W8731		

Monofilament Polypropylene Suture



Needle length and description				Length	Colour	Gauge					
▼ Straight Cutting						6-0 0.7	5-0 1	4-0 1.5	3-0 2	2-0 3	0 3.5
	KS-55	55mm	90cm	blue						W8571	
	KS	60mm	75cm	blue						W631	
	KS 2 beads & 2 collars	60mm	75cm	blue						W8631	
	KS 2 locking buttons	60mm	75cm	blue						W8623	
	KS fine 2 beads & 2 collars	60mm	75cm	blue					W630		
	KS fine 2 locking buttons	60mm	75cm	blue					W8630		
	KS fine	60mm	75cm	blue					W621		
	KS-75	75mm	100cm	blue					W751	W752	W753

Needle length and description				Length	Colour	Gauge					
	3/8 circle CS ULTIMA spatula				10-0 0.2	9-0 0.3	8-0 0.4	7-0 0.5	6-0 0.7	5-0 1	4-0 1.5
	CS140-6	6.5mm	30cm	blue	U7091						

▼ 3/8 circle Advanced MICRO-POINT spatula				10-0 0.2	9-0 0.3	8-0 0.4	7-0 0.5	6-0 0.7	5-0 1	4-0 1.5
	TG140-6	6.5mm	30cm	blue	W1777					

▼ 3/8 circle MICRO-POINT spatula				10-0 0.2	9-0 0.3	8-0 0.4	7-0 0.5	6-0 0.7	5-0 1	4-0 1.5
	TG140-8	6.5mm	23cm	blue	W1711	W1709				
	TG140-8	6.5mm	30cm	blue	W1710					

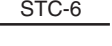
▼ 1/4 circle TAPERCUT				10-0 0.2	9-0 0.3	8-0 0.4	7-0 0.5	6-0 0.7	5-0 1	4-0 1.5
	CIF-4	13mm	20cm	blue	788G					

▼ Straight MICRO-POINT				10-0 0.2	9-0 0.3	8-0 0.4	7-0 0.5	6-0 0.7	5-0 1	4-0 1.5
	STC-6	16mm	15cm loop	blue	EH7900G					
	STC-6	16mm	23cm	blue	W1713					

▼ 1/4 circle Spatula				10-0 0.2	9-0 0.3	8-0 0.4	7-0 0.5	6-0 0.7	5-0 1	4-0 1.5
	CTC-6L	13mm	10cm loop	blue	EH7896G					

Monofilament Polypropylene Suture

Needle length and description		Length	Colour	Gauge						
⊙ 3/8 circle Taper Point				10-0 0.2	9-0 0.3	8-0 0.4	7-0 0.5	6-0 0.7	5-0 1	4-0 1.5
BV75-3 ☺	3.8mm	13cm	blue	W2790						
BV100-4 ☺	5mm	13cm	blue	W2794	W2783					
BV130-4 ☺	5mm	13cm	blue		W2780					

Monofilament Polypropylene Suture

ENDOLOOP Ligature

Pre-tied ligatures with Cannula for use during endoscopic surgery

Gauge		blue 45cm
2-0	3	EH464G



Capitalised product names are trademarks of ETHICON.